

Intersurgical Home Care Catalog

Continuing care from hospital to home

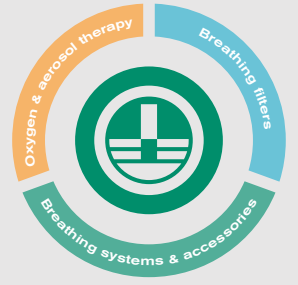

Breathing Systems and
Accessories



Oxygen and
Aerosol Therapy



Breathing Filters, HMEs, HMEFs
and Patient Connections



Edition 2



Quality, innovation and choice

www.intersurgical.com



To provide best practice respiratory product solutions for patients and clinicians, offering quality, innovation and choice.

Intersurgical

Intersurgical is a global designer, manufacturer and supplier of a wide range of high quality medical devices for respiratory support. We provide flexible patient solutions for airway management, anesthesia, critical care and oxygen & aerosol therapy, for use within emergency care, hospitals and also in the home.

With over 35 years experience, we understand the changing and challenging clinical environments and needs of our customers and their patients.

Our integrated approach enables us to provide the highest standards in design, manufacture, quality and customer care allowing us to respond quickly and effectively to our customers and consistently meet their requirements.

Our company goal is to provide best practice respiratory product solutions for patients and clinicians, offering quality, innovation and choice.



Quality	Innovation	Choice
<p>All of our products are designed and manufactured to meet the requirements of relevant international, European and national standards, and our Management System is assessed and certified as meeting the requirement of ISO 13485.</p>	<p>Innovation is important in all areas, helping us to deliver high quality products and services matched by cost effective solutions to meet today's needs.</p>	<p>Our wide product portfolio allows for both patient and clinical requirements to be met.</p>

We are also committed to lowering the environmental impact of our products and services and have implemented an Environmental Management System certified to international standard ISO 14001.

Be assured we can provide a solution for your needs.



Contents

	Introduction	4
	Guide to the Catalog	4
	Breathing Systems and Accessories	5
	Breathing Systems.....	6
	Humidification Chambers.....	8
	Anesthetic Face Masks.....	10
	Accessories and Connectors.....	11
	Breathing Filters, HMEs, HMEFs and Patient Connections	17
	Breathing Filters, HMEs and HMEFs.....	18
	Patient Connections.....	23
	Oxygen and Aerosol Therapy	26
	Oxygen Therapy	27
	Aerosol Therapy	33
	Nebulizer Therapy	35

Intersurgical Home Care

Many of the products we develop as a company are designed for use in both hospital and home. These products have allowed us to create a Home Care range focused on the home care patient, whether they are ventilated or using oxygen. We aim to offer a solution to all your home ventilatory and oxygen delivery requirements and understand each patient is different. Because of this, we offer the widest possible range.





The range includes single and dual limb breathing systems suitable for a wide range of home care ventilators, lengths of tube for CPAP applications through to nasal cannula for oxygen therapy.

If you are unable to find a solution for your needs then please contact us to discuss specific requirements.



A guide to symbols used in this catalog

Throughout the catalog, we use a number of symbols to identify specific characteristics about our products. Please familiarize yourself with these symbols below.

 <p>Lower environmental impact</p> <p>The Eco range of products has been designed as part of our ongoing focus on sustainable development. Wherever you see the  logo, we have reduced the environmental impact of these products compared with traditional PVC options.</p>	 <p>View product video</p> <p>We have a large number of product videos to demonstrate how our products can be used and their features and benefits. These can be viewed on the product pages of our website.</p>	  <p>Single use and Latex free</p> <p>All products detailed in this catalog are single-use and latex free unless otherwise stated.</p>
---	--	---

A guide to our ports and caps

Ports and caps are available on a variety of products including catheter mounts, elbows, T-pieces, Y-pieces and connectors. For added safety all Intersurgical port caps are fixed to the connectors, to prevent loss or misplacement in use.

 Video available at www.intersurgical.com

<p>Luer ports</p> <p>For secure attachment of gas sampling lines with luer lock fittings</p> 	<p>7.6mm port and flip top cap</p> <p>For insertion of all standard 7.6mm probes or for suctioning</p> 	<p>Double flip top cap with seal</p> <p>Bronchoscopy and suction ports in one patient connection</p> <div style="display: flex; justify-content: space-around;"> <div style="text-align: center;">  <p>First tab open – bronchoscope mode with seal</p>  </div> <div style="text-align: center;">  <p>Second full cap open – suction mode</p>  </div> </div>
---	---	--



Breathing Systems and Accessories

The range includes single and dual limb breathing systems suitable for a wide range of home care ventilators, lengths of tube for CPAP applications and a choice of connectors and accessories.

Breathing Systems.....	6
Humidification Chambers.....	8
Anesthetic Face Masks.....	10
Accessories and Connectors.....	11

Single limb breathing systems designed for hospital and home

The single limb breathing system with exhalation valve range has been designed with the patient in mind. This range features our exhalation valve popular for its user-friendly characteristics and exceptional design. It is fully compatible with the majority of home care ventilators.

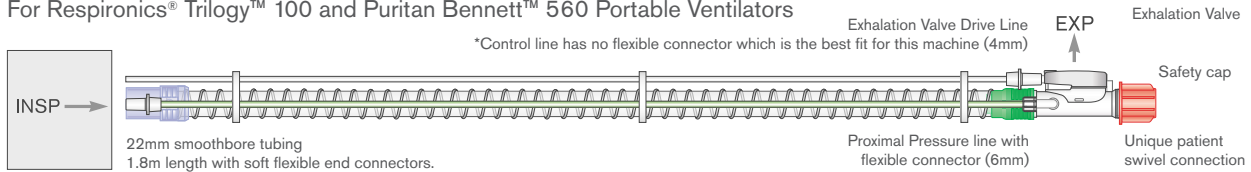

Intersurgical® 5191030For Respiration[®] Trilogy™ 100 and Puritan Bennett™ 560 Portable Ventilators

Code	Description	Box Qty.
5191030	22mm Smoothbore breathing system with monitoring line and exhalation valve, single limb, ≥1.8m	25

Intersurgical® 5183030

Universal Circuit for Home Care Ventilators

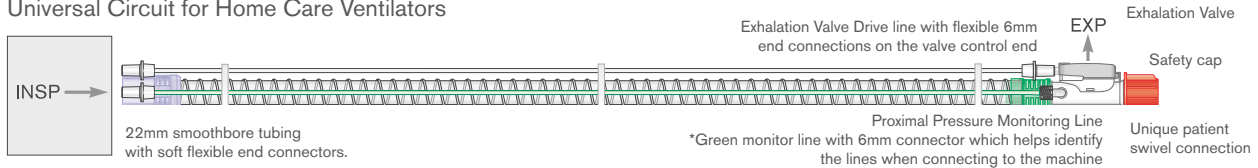

Code	Description	Box Qty.
5183030	22mm Smoothbore breathing system with monitoring line and exhalation valve, ≥1.6m	10

Intersurgical® 5182030

Universal Circuit for Home Care Ventilators that do not require a Proximal Monitoring Line

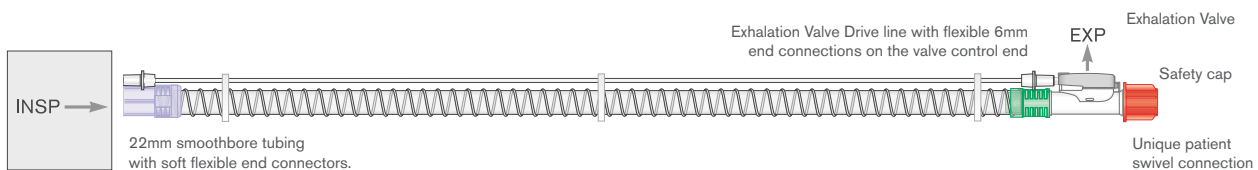

Code	Description	Box Qty.
5182030	22mm Smoothbore single limb breathing system with exhalation valve, ≥1.6m	10

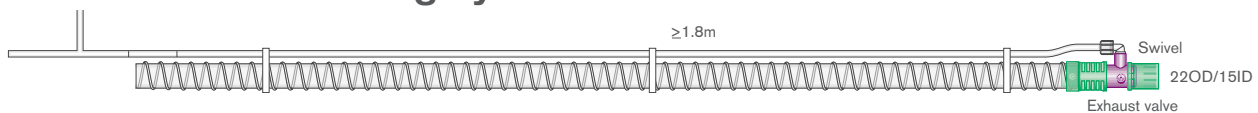
Smoothbore breathing systems for bi-level ventilators

👁️ system illustrated

Code	Description	Box Qty.
👁️ B0006000	Smoothbore circuit with vent and end T	10
B0006001	Smoothbore circuit with vent, end T and tube hanger	10
B0006002	Smoothbore circuit with vent	10
B0006003	Smoothbore circuit with vent and tube hanger	10
B0063000	Smoothbore breathing system without exhalation port, 22mm, ≥1.6m	10
B0062001	Smoothbore breathing system with exhalation port 22mm, ≥1.6m	10
B0003000	Smoothbore circuit with vent, 1644030 filter and end T	10
B0003001	Smoothbore circuit with vent, 1644030 filter, tube hanger and end T	10
B0003002	Smoothbore circuit with vent and 1644030 filter	10
B0003003	Smoothbore circuit with vent, 1644030 filter and tube hanger	10

Covidien is a registered trademark of Covidien AG. Puritan Bennett is a registered trade mark of Covidien LP.

Respiration[®] is a registered trademark of Respiration, Inc.

Make an inquiry

Humidification chambers

The humidification chamber is an integral part of the breathing system, allowing it to interface with the heated humidifier base. The range consists of three chamber options for use with humidifier bases. Simply slide the chamber into position on the hot plate of the base controller, allowing the inspiratory gas to pass over the heated water. Chambers can be purchased individually or as part of a breathing system package.

The auto-fill humidification chamber offers a fixed level of water within the chamber, ensuring a constant system volume. This, coupled with the strong polycarbonate body and non-compressible float, ensures that adverse changes in system compliance are reduced to a minimum. The chamber provides optimum humidification output without compromising resistance to flow. The dual float, dual-valve design provides further assurance of reliability.

▶ Video available at www.intersurgical.com

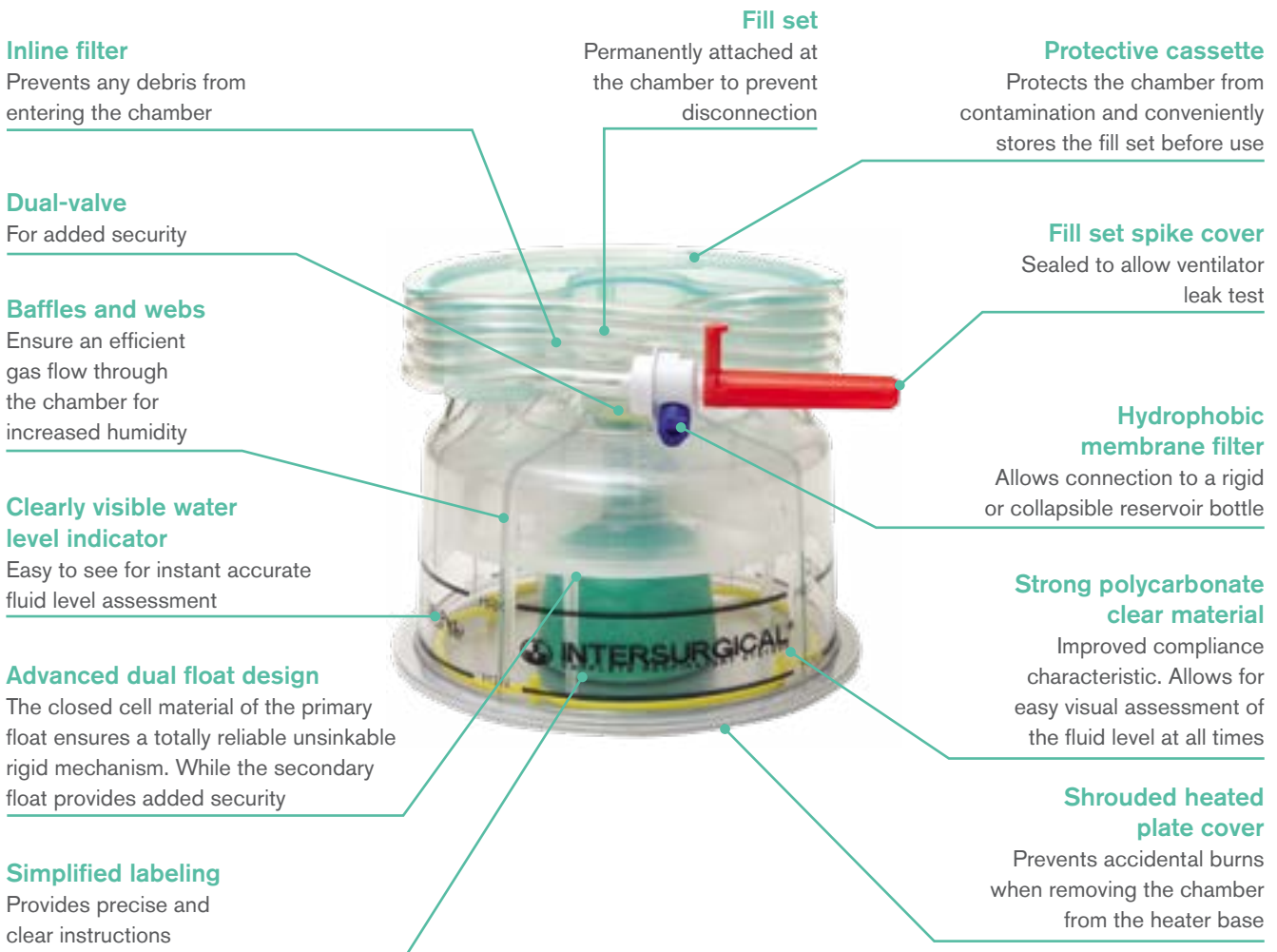

[Make an inquiry](#)

Code	Description	Box Qty.
2310030	Auto-fill humidification chamber with fill set	30
2320030*	Manual fill humidification chamber with fill set and clamp	30
2330030*	Low volume manual fill humidification chamber with fill set and clamp	30

* The product is supplied with a fill set and clamp for manually controlling the water level in the chamber.

Flextube™ breathing systems for active humidification with heated wire

Breathing systems are available with dual and single limb heated wires and can be supplied complete with an auto-fill humidification chamber if required. All Intersurgical active humidification breathing systems are suitable for use with the majority of humidification base units.

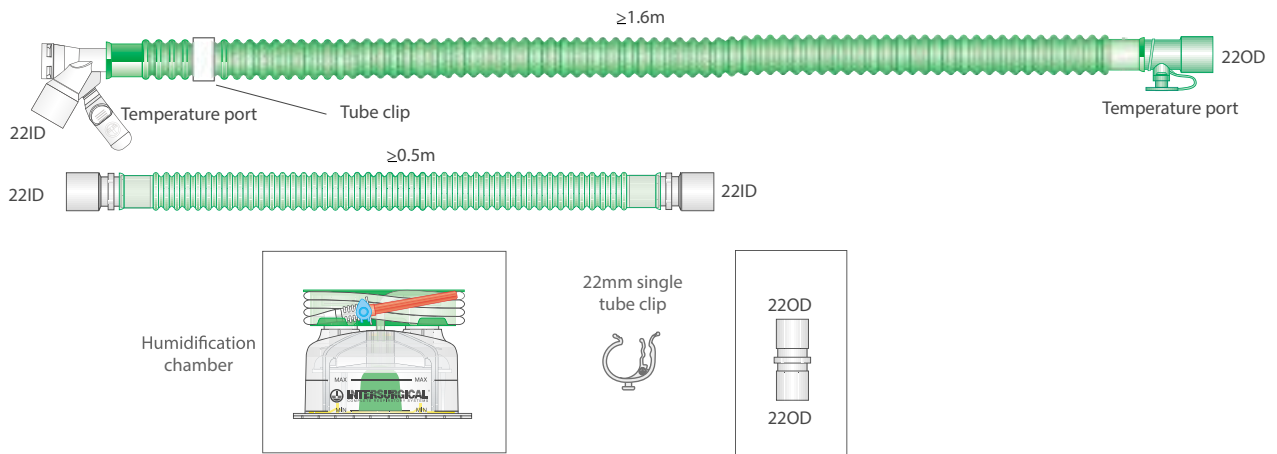
[Make an inquiry](#)

Code	Description	Box Qty.
2026035	22mm Flextube single limb heated system with limb, $\geq 1.6\text{m}$ length	20
 2026036	2mm Flextube single limb heated system with auto-fill chamber and limb, $\geq 1.6\text{m}$ length	7
2026030A	22mm Flextube dual heated wire breathing system with limb, $\geq 1.6\text{m}$ length	10
2026031A	22mm Flextube dual heated wire breathing system with auto-fill chamber and limb, $\geq 1.6\text{m}$	7

ClearLite™ anesthetic face masks

A range of anesthetic face masks which includes seven sizes to meet the clinical needs of most patient types and sizes. The range is available in size 0 neonate to size 6 extra large adult. Due to the enhanced anatomical design, the ClearLite mask offers superior seal performance with minimal pressure, reducing the risk of unnecessary discomfort or potential trauma.

The superior seal will also assist the clinician in providing optimum manual ventilation of the patient in both the anesthetic and emergency situation. ClearLite is non-PVC and phthalate free which significantly minimizes the impact on the environment. 

Lightweight mask

Provides enhanced grip and comfort in use for the clinician

Anatomical shape

Provides a precise fit for different face types and sizes. Minimal pressure is required to achieve an effective seal, reducing the risk of inadvertent trauma and nerve damage

Crystal clear body

Provides excellent visibility for confirmation that the patient is well perfused

Reduced mask volume

Reduces potential rebreathing and risks associated with elevated levels of end tidal CO₂

Safe and secure connection

This is achieved between the mask and the breathing system in use. The ISO 22mm tapered connection complies with ISO 5356

Flexible non-inflatable cuff

Provides a comfortable and effective airtight seal









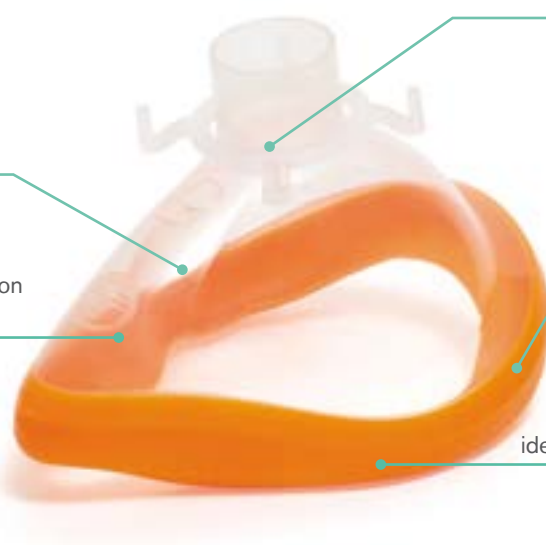





Color-coding

The comfortable, flexible seal is color coded to allow quick and easy identification of the correct sized mask

Low environmental impact

Non-PVC and phthalate free



Code	Description	Box Qty.
 7296000	ClearLite, anesthetic face mask, size 6, extra large adult, red seal, 22ID	20 
 7295000	ClearLite, anesthetic face mask, size 5, large adult, orange seal, 22ID	35 
 7294000	ClearLite, anesthetic face mask, size 4, adult, green seal, 22ID	35 
 7293000	ClearLite, anesthetic face mask, size 3, small adult, yellow seal, 22ID	35 
 7292000	ClearLite, anesthetic face mask, size 2, pediatric, white seal, 22ID	25 
 7291000	ClearLite, anesthetic face mask, size 1, infant, grey seal, no hook ring, 15OD	30 
 7290000	ClearLite, anesthetic face mask, size 0, neonate, blue seal, no hook ring, 15OD	40 

Make an inquiry

 Lower environmental impact product

Tube management program clip system

Don't Trip, Clip

Breathing systems that drag across the floor are not hygienic and can cause accidents. Our tube management clip system comprises two U-shaped brackets, a single tube clip and a double tube clip to keep bagging limbs and tubes secure. The U-shaped bracket is self adhesive and can be used with the red safety cap supplied with our systems or the tube clips.

Tube clips 22mm

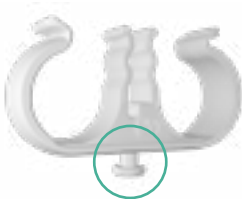

Notch feature



Red safety cap or humidification chamber fill set spike cover



Notch feature



Notch feature interfaces with



Tube management clip



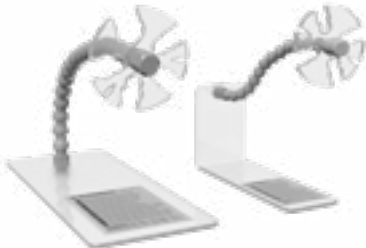

Tube holder

Our ergonomically designed tube holder is a neat way of supporting a breathing system close to the patient. Available in two sizes the tube support efficiently holds in place 10, 15, 22 and 30mm tube with a smaller groove to grip monitoring lines and cables. The flexible neck is easily positioned to take the strain of the breathing system away from the patient.

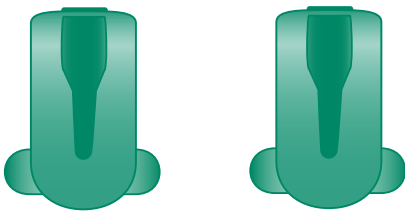

Tube management guide

Tube management clips		Tube clips	
			
Code	2316030		
Box Qty.	12		

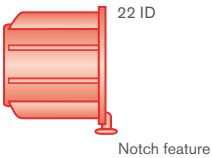
	
Code	19786000
Box Qty.	25

Tube holder 30mm/22mm/ 15mm	
	
Code	59046000
Box Qty.	1

Tube holder 15mm/10mm	
	
Code	59056000
Box Qty.	1

[Make an inquiry](#)

Water traps

We offer a range of self-sealing water traps that allow for emptying during use. As the base of the water trap is opened, the internal valve automatically closes ensuring the breathing system remains airtight. As the base is replaced, the valve re-opens allowing drainage of the breathing system to recommence.

The right-angled version is ideal for use in applications where a 90° attachment may be required.



1912030

1916000

Code	Description	Box Qty.
1911030	Water trap, self-sealing, medium, 70ml	40
1912030	Water trap, self-sealing, large, 125ml	50
1915000	Water trap, right-angled, self-sealing, large 125ml	40
1916000	Water trap, right-angled, self-sealing, medium 70ml	55

[Make an inquiry](#)

22mm straight connectors and mouthpieces

Make an inquiry



Code	19606000
Box Qty.	50

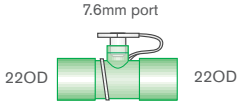



Code	19666000
Box Qty.	50

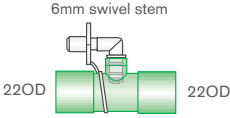

 illustrated



Code	19656000 
Box Qty.	50



Code	19696000
Box Qty.	50



Code	19616000
Box Qty.	50



Code	19646000
Box Qty.	50

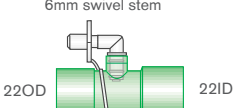

Code	19636000
Box Qty.	50



Code	19336000
Box Qty.	50



Code	19676000
Box Qty.	50



Code	19756000
Box Qty.	50



Code	19706000
Box Qty.	50



Code	19716000
Box Qty.	50



Code	1930030
Box Qty.	50



Code	1931030
Box Qty.	50

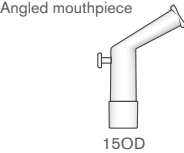

Code	1937000
Box Qty.	20

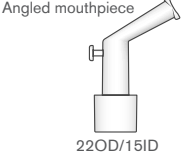

Code	1938000
Box Qty.	15

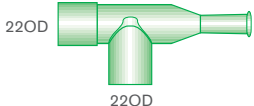

Code	15106000
Box Qty.	50



Code	19686000
Box Qty.	50



Code	15686000
Box Qty.	50



Code	19786000
Box Qty.	25

15mm straight connectors

Make an inquiry



15OD 15OD

Code	19456000 
Box Qty.	50



15OD 15ID

Code	19466000
Box Qty.	50



 illustrated

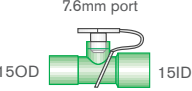

7.6mm port
15OD 15ID

Code	19476000
Box Qty.	50

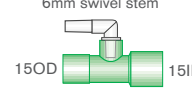

6mm swivel stem
15OD 15ID

Code	1948030
Box Qty.	50



15ID 15ID

Code	19496000
Box Qty.	50



15OD 22OD

Code	19436000
Box Qty.	50



22OD/15ID Large oxygen stem 6.5mm

Code	19746000
Box Qty.	50



15OD 22ID

Code	19626000
Box Qty.	50



15ID 22ID

Code	19796000
Box Qty.	50

Elastomeric soft connectors

Make an inquiry



22mm lipped or non-ISO connector 22ID 15ID

Code	17016000
Box Qty.	50



15ID 6-9mm spigot or non-ISO

Code	1702000
Box Qty.	50



 illustrated



15ID 9-11mm spigot or non-ISO

Code	17036000
Box Qty.	50



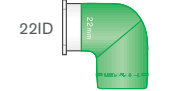

22ID 22mm lipped or non-ISO connector

Code	17046000
Box Qty.	50



22ID 22mm lipped or non-ISO connector

Code	17056000 
Box Qty.	50



22ID 22mm lipped or non-ISO connector

Code	17066000
Box Qty.	50

Directional valves

Make an inquiry

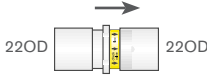

Code	19506000
Box Qty.	50

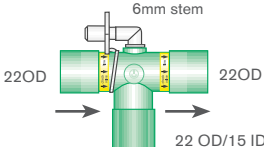

Code	19586000
Box Qty.	50

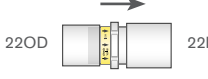

Code	19516000
Box Qty.	50

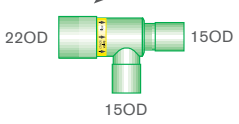

Code	19556000
Box Qty.	50

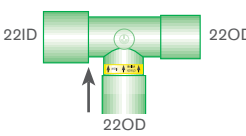

Code	19526000
Box Qty.	50

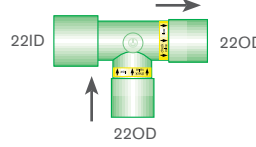

Code	19536000
Box Qty.	50

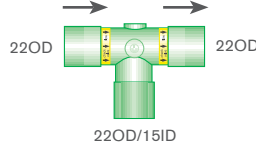

Code	19546000
Box Qty.	50

T-piece connectors

Make an inquiry

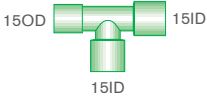

Code	18026000
Box Qty.	50

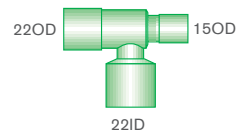

Code	19896000
Box Qty.	50



illustrated

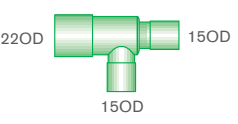

Code	19886000
Box Qty.	50

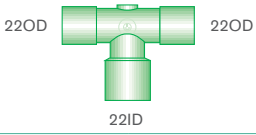

Code	19816000
Box Qty.	50

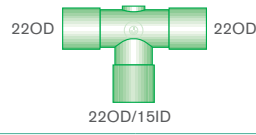

Code	19806000
Box Qty.	50

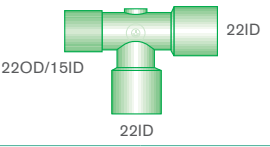

Code	19836000
Box Qty.	50

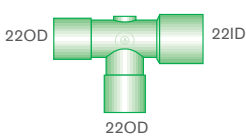

Code	19826000
Box Qty.	50

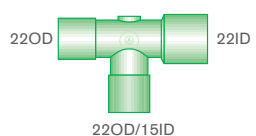

Code	19856000
Box Qty.	50

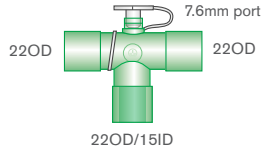

Code	19846000
Box Qty.	50

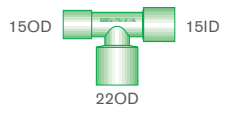

Code	18006000
Box Qty.	50

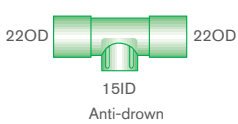

Code	19596000
Box Qty.	50

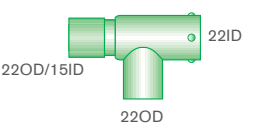

Code	19866000
Box Qty.	50

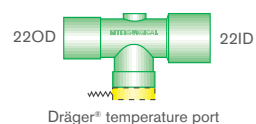

Code	19876000
Box Qty.	50

Y-piece connectors

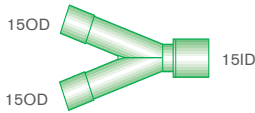

Code	19026000
Box Qty.	50

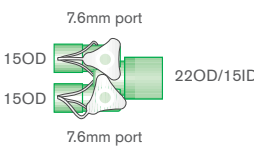

Code	1903000
Box Qty.	25



 illustrated

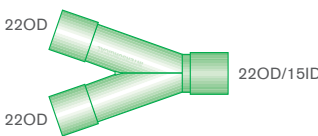

Code	19006000
Box Qty.	50

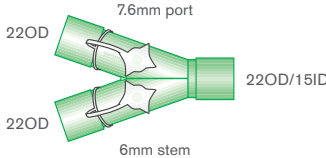

Code	19016000 
Box Qty.	50

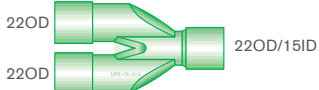

Code	19266000
Box Qty.	50

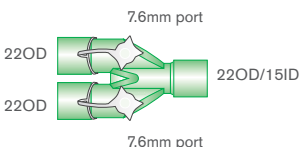

Code	1927000
Box Qty.	15

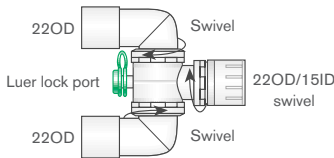

Code	19296000
Box Qty.	50

Make an inquiry



Breathing Filters, HMEs, HMEFs and Patient Connections

A range of products designed for the protection of the patient and equipment. Patient connectors are available with a variety of options.

Breathing Filters, HMEs and HMEFs.....	18
Patient Connections	23

Use of Breathing Filters

Breathing filters provide an effective barrier that prevent cross contamination between patients, respiratory breathing systems, equipment and the clinical environment. Their use is widely recognized as beneficial and is recommended by a number of Anesthetic Associations¹.

The threat to patients

Patients who require an artificial airway have their natural physiological protection bypassed. This will increase the risk of cross contamination between patients and healthcare equipment. The cross contamination of patients via an anesthetic system has been reported, and documented areas of concern regarding infection includes *Hepatitis C*, *Mycobacterium tuberculosis*, blood in sputum and the *SARS virus*.

Critically ill patients are commonly at risk of infection, particularly from Ventilator Associated Pneumonia (V.A.P.). This nosocomial infection increases morbidity and potential mortality as well as the cost of treatment costs. The strategic use of an efficient breathing filter will provide an effective barrier between patients, breathing systems and ventilatory equipment.

Proven efficiency

The Intersurgical range of breathing filters has been designed for the protection of the patient, breathing system and equipment. They have been independently tested and proven to be highly efficient in preventing the passage of bacteria and viruses. Clinically relevant testing is carried out on all products using *Bacillus subtilis* (1.0µm x 0.7µm) and Ø174 bacteriophage. Additional testing includes *Mycobacterium tuberculosis* (0.3µm x 1.0µm), *Hepatitis C* (0.03µm) and *MS-2 coliphage* (0.02µm). These tests provide you with clinically relevant information to allow evidence-based decisions to be made on the most appropriate product to meet your clinical requirements.

Potential infectious bacteria [Particle sizes µ microns]

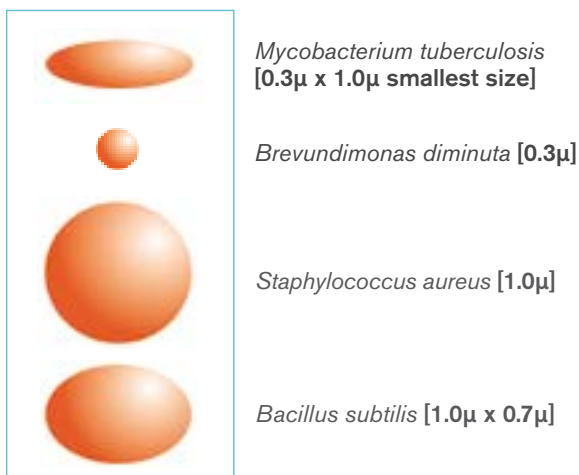

Essential requirements

The Intersurgical range of breathing filters offers a choice of electrostatic and pleated mechanical filters with a range of patient connections, providing a choice of products to meet various clinical situations.

- Independently validated Filtration Efficiency²
- Proven filtration against *Mycobacterium tuberculosis* and *Hepatitis C*
- Proven efficiency not affected by anesthetic agent
- Safe inert material
- Option of patient connections – conveniently packed and ready for use
- Lightweight – reducing patient trauma
- Low compressible volume – reducing rebreathing of CO₂
- Low resistance to flow – over 24 hours
- Safe, secure ISO connectors
- Compliance to all relevant international standards

Filtration efficiency

Filtration performance is determined by independent microbiological testing against clinically relevant bacterial and viral challenges. The level of breakthrough of the challenge determines the efficiency. This efficiency is reported as a percentage based upon this breakthrough.

Filtration Efficiency based on a challenge of 100,000 Microbes

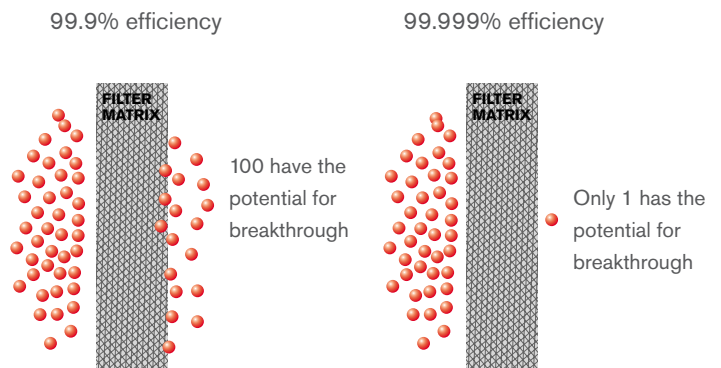

Potential infectious viruses [Particle sizes µ microns]

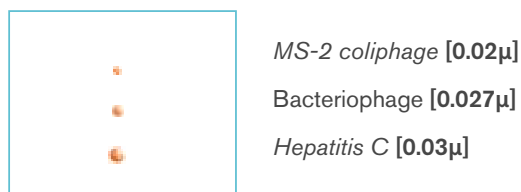

1. Association of Anaesthetists of Great Britain and Ireland 1996. Danish Society of Anaesthetists 1998. French Society of Anaesthetists 1998.

2. All filters are independently validated for filtration efficiency at the Health Protection Agency, Porton Down, Salisbury, Wiltshire, U.K and Nelson Laboratories Inc, USA. All quoted performance figures are mean values.

The Breathing filter range

Designed for the protection of the patient, the breathing system and the equipment.

- **Filta-Guard™**: high efficiency filter
- **Clear-Guard™ Midi**: low volume filter
- **Clear-Guard™ 3**: cost-effective filter with ergonomic housing
- **Hydro-Guard™ Mini Mk.II**: pleated media hydrophobic filter



Filta-Guard™



Clear-Guard™ Midi



Clear-Guard™ 3

Code	1944030	1644030	1544030
Box Qty.	40	50	40
Luer lock port		✓	✓
Filtration efficiency	>99.999%	>99.9%	>99.99%
Resistance to flow at 30L/min	1.0cm H ₂ O	0.7cm H ₂ O	0.8cm H ₂ O
Resistance to flow at 60L/min	2.3cm H ₂ O	1.8cm H ₂ O	1.9cm H ₂ O
Compressible volume	67ml	34ml	60ml
Weight	40g	19g	28g
Connectors	22ID - 22OD/15ID	22ID - 22OD/15ID	22ID/15OD - 22OD/15ID
Minimum tidal volume	>200ml	>100ml	>200ml



Clear-Guard™ II



Hydro-Guard™ Mini Mk.II

Code	1844030	1745030
Box Qty.	40	40
Luer lock port		✓
Filtration efficiency	>99.99%	>99.999%
Resistance to flow at 30L/min	0.9cm H ₂ O	1.3cm H ₂ O
Resistance to flow at 60L/min	1.8cm H ₂ O	2.9cm H ₂ O
Compressible volume	48ml	63ml
Weight	27g	30g
Connectors	22ID/15OD - 22OD/15ID	22ID/15OD - 22OD/15ID
Minimum tidal volume	>150ml	>200ml

[Make an inquiry](#)

Filters for equipment protection

Designed for the protection of equipment and the environment from contamination at the machine end.

[Make an inquiry](#)

Flo-Guard

Low resistance filter

The Flo-Guard breathing filter is designed to be used at the machine-end of a breathing system to protect the patient and machine against cross contamination, while maintaining a low resistance across a wide range of flow rates.

The low resistance makes it an ideal filter for use in both the hospital and home setting, where high flow rates may potentially be used; this includes CPAP, Bilevel and CoughAssist® applications.

The Flo-Guard provides an excellent bacterial and viral filtration efficiency while offering a low resistance to flow even at very high flow rates.



Code	1690030
Box Qty.	50
Filtration efficiency	>99.99%
Resistance at 30L/min	0.4cm H ₂ O
Resistance at 60L/min	0.8cm H ₂ O
Resistance at 90L/min	1.4cm H ₂ O
Resistance at 120L/min	2.0cm H ₂ O
Resistance at 150L/min	2.7cm H ₂ O
Resistance at 180L/min	3.4cm H ₂ O
Resistance at 210L/min	4.3cm H ₂ O
Resistance at 240L/min	5.1cm H ₂ O
Compressible volume	80ml
Weight	27.8g
Connectors	22ID - 22OD

Air-Guard™ Clear

The Air-Guard Clear filter is a hydrophobic pleated membrane filter, designed for the protection of oxygen concentrator machines and other respiratory equipment.

The Air-Guard Clear filter will function as a microbial filter when used to protect oxygen concentrator machines or when used in breathing systems to protect equipment from contamination. Its filtration effectiveness has been tested in accordance with the test method described in ISO EN 23328 - Part 1. It offers HEPA performance and has been independently tested to determine effectiveness against viruses and bacteria.

This product excels as a bacterial and viral filter and can be used as such in a respiratory system providing the maximum period of use is 24 hours, which corresponds to the usual protocols and procedures concerning breathing filters.



Code	1790030
Box Qty.	50
Filtration efficiency	>99.9999%
Resistance to flow at 30L/min	0.9cm H ₂ O
Resistance to flow at 60L/min	1.9cm H ₂ O
Compressible volume	120ml
Weight	56g
Connectors	22ID - 22OD/15ID
Minimum tidal volume	>360ml

Respiratory system protection

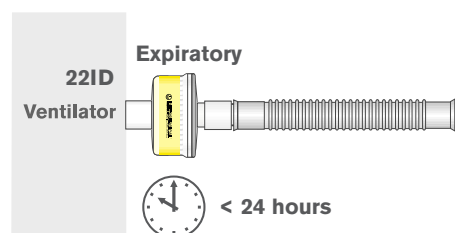

Oxygen concentrator protection

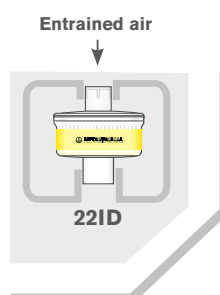

[Make an inquiry](#)

Please note: this product is contraindicated for use at the patient connection end of the breathing system.

CoughAssist is a registered trade mark of Respirationics, Inc.

Heat and Moisture Exchangers (HMEs)

In normal respiration the anatomy of the upper airway helps to warm and humidify inspired air, and to retain the warmth and moisture contained in expired air. During inspiration, even cold or dry air is typically heated to 37 °C and, fully saturated, contains 44mg H₂O per liter. In mechanical ventilation or anesthesia, the patient's upper airway may be bypassed by the introduction of a tracheal tube. As a result, the patient's lungs may be confronted with cold, dry, inspired gas.

Prolonged exposure to dry ventilatory gases can lead to:

- Localized inflammation of the trachea
- A reduction in ciliary function
- Retention and thickening of secretions
- Lowering of patient temperature
- Reduction in cardiopulmonary function
- Increased risk of tracheostomy tube occlusion
- Extended duration and cost of care

Respiratory epithelium adversely affected by heat & moisture loss

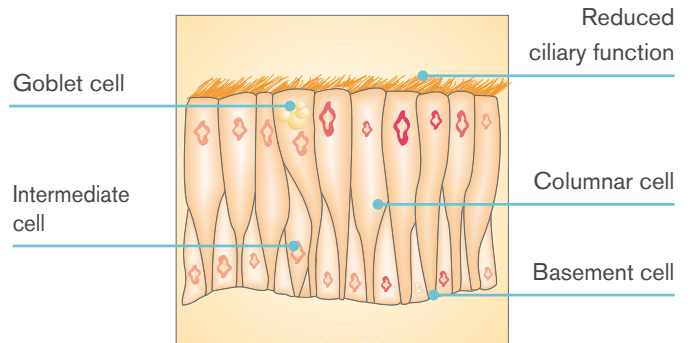

Hydro-Trach™ T range

A heat and moisture exchanger designed for use on tracheostomized patients. The Hydro-Trach T is an ideal product for prolonged use with spontaneously breathing patients.

Clear housing

For easy visual inspection of possible secretion build up



Anti-occlusion mechanism

Allows the HME element to partially dislodge in the event of total occlusion or vigorous cough

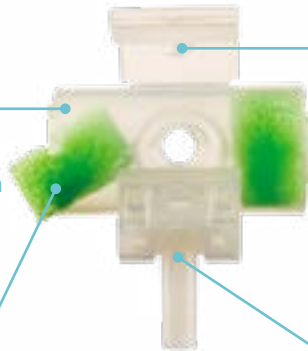

Clipped suctioning port

Allows for easier suctioning without removal of the device

Small and lightweight

Reduces pull on the patient connection

An integral swivel oxygen connector (except 1870000 and 1871030)

Allows for connection of the oxygen tube without the need of a separate oxygen adapter, which can be easily folded away when not in use

Video available at www.intersurgical.com

Code	1873030	1874030	1870000	1871030
Box Qty.	50	40	25	40
Moisture loss	13.2mg H ₂ O/L	13.2mg H ₂ O/L		
Calculated moisture return	26mg H ₂ O/L	26mg H ₂ O/L		
Resistance at 30L/min	0.2cm H ₂ O	0.2cm H ₂ O	0.3cm H ₂ O	0.3cm H ₂ O
Resistance at 60L/min	0.7cm H ₂ O	0.7cm H ₂ O	0.7cm H ₂ O	0.7cm H ₂ O
Compressible volume	19ml	19ml + O ₂ tube	17ml	17ml + O ₂ tube
Weight	8g	8g	6g	6g
Connectors	15ID	15ID	15ID	15ID
Minimum tidal volume	>60ml	>60ml	50ml	50ml
Accessories		1.8m oxygen tube		1.8m oxygen tube

Make an inquiry

Hydro-Therm™ HME range

A dedicated range of Heat and Moisture Exchangers designed to replicate the functions of the body's upper airway by conserving expired heat and moisture and returning these to the patient during inhalation. The Hydro-Therm is a small-volume, lightweight device which is clinically suitable over a wide range of patient sizes.

[Make an inquiry](#)



Code	1850030	1855000	18506500	18536500
Box Qty.	50	20	50	50
Luer lock port		✓		✓
Moisture loss	7.8mg H ₂ O/L	7.8mg H ₂ O/L	7.8mg H ₂ O/L	7.8mg H ₂ O/L
Calculated moisture return	30.8mg H ₂ O/L	30.8mg H ₂ O/L	30.8mg H ₂ O/L	30.8mg H ₂ O/L
Resistance to flow at 30L/min	0.5cm H ₂ O	0.5cm H ₂ O	0.5cm H ₂ O	0.5cm H ₂ O
Resistance to flow at 60L/min	1.6cm H ₂ O	1.6cm H ₂ O	1.6cm H ₂ O	1.6cm H ₂ O
Compressible volume	20ml	20ml	20ml*	20ml*
Weight	11.8g	11.8g	11.8g*	11.8g*
Connectors	15OD – 22OD/15ID	15OD – 22OD/15ID	15OD/15ID	15OD/15ID
Minimum tidal volume	>60ml	>60ml	>60ml	>60ml
Accessories			Flextube™	Flextube™

Hydro-Therm™ 3 HME range

A dedicated range of heat and moisture exchangers designed to replicate the functions of the body's upper airway by conserving expired heat and moisture and returning these to the patient during inhalation. The Hydro-Therm 3 is a large-volume HME with rounded housing for use in anesthesia and intensive care.

[Make an inquiry](#)



Code	1560030	15606500
Box Qty.	40	20
Luer lock port	✓	✓
Moisture loss	6.7mg H ₂ O/L	6.7mg H ₂ O/L
Calculated moisture return	31.6mg H ₂ O/L	31.6mg H ₂ O/L
Resistance at 30L/min	0.2cm H ₂ O	0.2cm H ₂ O
Resistance at 60L/min	0.8cm H ₂ O	0.8cm H ₂ O
Compressible volume	59ml	59ml*
Weight	31g	31g*
Connectors	22ID/15OD – 22OD/15ID	22ID/15OD – 15ID
Minimum tidal volume	>200ml	>200ml
Accessories		Flextube™

*HME only

Double swivel elbows

A range of double swivel elbows providing added mobility at the patient connection, with a variety of ports for all clinical applications. All Intersurgical port caps are fixed to the connectors for added safety, this prevents loss or misplacement in use.

Please see page 4 for the guide to ports and caps

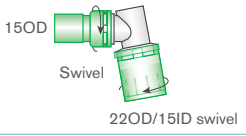

15OD
Swivel
22OD/15ID swivel

Code	1897000
Box Qty.	30

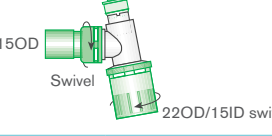

Flip top cap with 7.6mm port
15OD
Swivel
22OD/15ID swivel

Code	1899000
Box Qty.	30

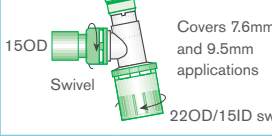

Double flip top cap with seal
15OD
Swivel
22OD/15ID swivel
Covers 7.6mm and 9.5mm applications

Code	1898000 
Box Qty.	30



Illustrated 

Make an inquiry

Fixed elbows

A range of fixed elbow connections with a variety of ports for a number of clinical applications. All Intersurgical port caps are fixed to the connectors for added safety, this prevents loss or misplacement in use.

Please see page 4 for the guide to ports and caps

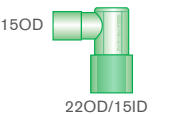

15OD
22OD/15ID

Code	1997000
Box Qty.	30

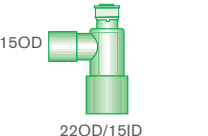

Flip top cap with 7.6mm port
15OD
22OD/15ID

Code	1993030 
Box Qty.	50

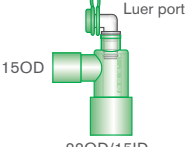

15OD
Luer port
22OD/15ID

Code	2714030
Box Qty.	50



Illustrated 

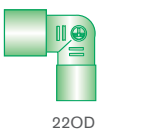

22ID
22OD

Code	19926000
Box Qty.	50

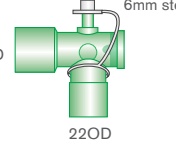

22ID
6mm stem
22OD

Code	19916000
Box Qty.	50

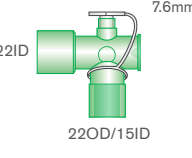

22ID
7.6mm port
22OD/15ID

Code	1893000
Box Qty.	25

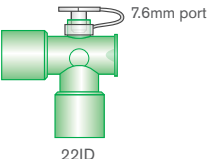

22ID
7.6mm port
22ID

Code	18916000
Box Qty.	50

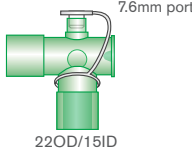

22OD
7.6mm port
22OD/15ID

Code	1995000
Box Qty.	25

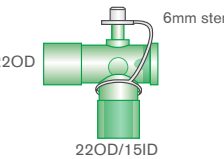

22OD
6mm stem
22OD/15ID

Code	19906000
Box Qty.	50

Make an inquiry

Flexible catheter mounts

A range of flexible catheter mounts available with a variety of elbow connections and ports for all applications. All Intersurgical port caps are fixed to the connectors for added safety. This prevents loss or misplacement in use.

Please see page 4 for the guide to ports and caps



Illustrated

Code	3511000
Box Qty.	50

Code	3510031
Box Qty.	50

Code	3506000
Box Qty.	50

Code	3507031
Box Qty.	50

Make an inquiry

Superset™ catheter mounts

Superset catheter mounts have a concertina design to allow for complete positioning control.

The design allows the adjustment of compressible volume and the adjustment of length from 70mm to 150mm, excluding connectors.

The range is available with fixed and double swivel elbows and a variety of ports for all applications. For added safety all Intersurgical port caps are fixed to the connectors, to prevent loss or misplacement in use.

Please see page 4 for our Guide to ports and caps.



Illustrated

70-150mm
22ID 22OD/15ID

Code 3504031S

Box Qty. 50

70-150mm
22ID 22OD/15ID

Code 3502030

Box Qty. 50

70-150mm Luer lock port
22ID 22OD/15ID

Code 3514031

Box Qty. 50

70-150mm Swivel
22ID 22OD/15ID

Code 3512000

Box Qty. 75

Flip top cap with 7.6mm port
70-150mm Swivel
22ID 22OD/15ID

Code 3509031

Box Qty. 50

Double flip top cap with seal
70-150mm Swivel
22ID 22OD/15ID

Covers 7.6mm and 9.5mm applications

Code 3521000

Box Qty. 75

22ID 15ID

Code 91236000

Box Qty. 50

7.6mm port
100mm
15OD 15ID

Code 35326000

Box Qty. 50

Make an inquiry

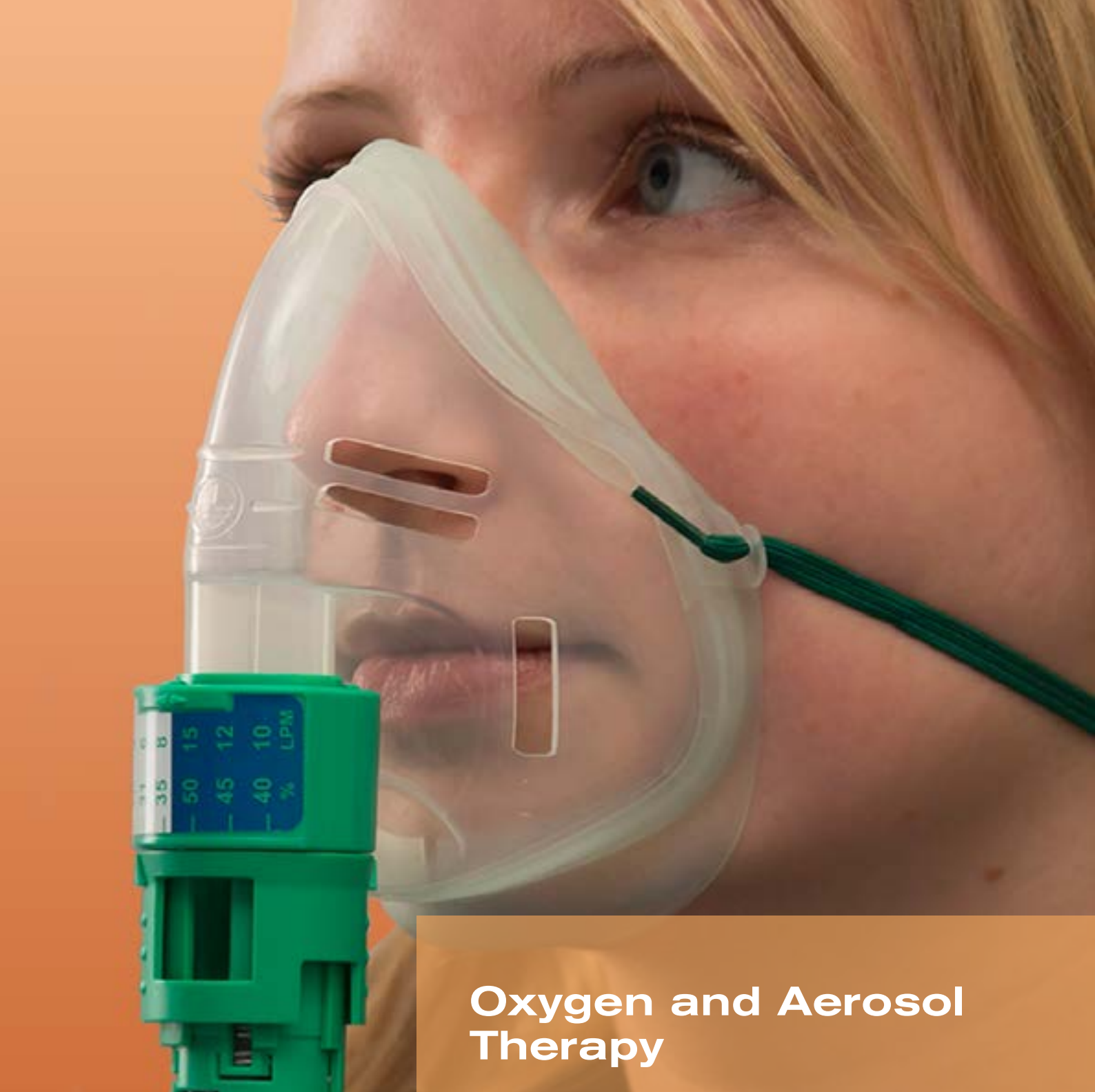

Oxygen and Aerosol Therapy

A range of products dedicated to oxygen delivery, humidification of oxygen and nebulization of drugs.

Oxygen Therapy	27
Aerosol Therapy	33
Nebulizer Therapy	35

Nasal cannulas

Conventional nasal cannulas

A range of products for adult, pediatric and neonates are available with a wide selection of prong shapes to suit all patient requirements. All oxygen tubing in the range is manufactured in a 'multi-channel' design, which permits oxygen flow even if the tubing is 'kinked'. The ear guard option includes soft silicone foam cushions, which are easily adjusted and securely fitted to prevent trauma to the patient's ears.

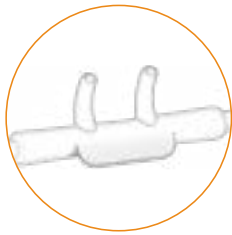

Curved prongs:
Improved anatomical shape and fit

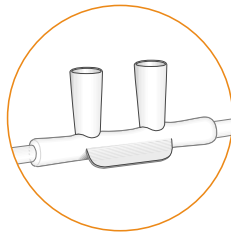

Flared prongs:
Slow down the flow of oxygen

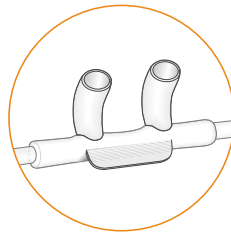

Curved and Flared prongs:
Combines the benefits of both

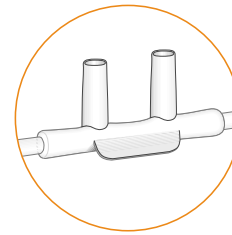

Straight prongs



Curved prongs with ear guards:
Improved anatomical fit and patient comfort

Code	Description	Tube Length	Box Qty.
1161030	Adult, nasal cannula with straight prongs and tube	2.1m	50
1165030	Adult, nasal cannula with curved prongs and tube	2.1m	50
1165002	Adult, nasal cannula with curved prongs, ear guards and tube	2.1m	50
1166030	Adult, nasal cannula with flared prongs and tube	2.1m	50
1167030	Adult, nasal cannula with curved/flared prongs and tube	2.1m	50
1163030	Pediatric, nasal cannula with curved prongs and tube	2.1m	50
1164030	Neonatal, nasal cannula with curved prongs and tube	2.1m	50



Phthalate free nasal cannulas

The phthalate-free range of nasal cannula has been designed to address the concerns of neonatal exposure to DEHP in premature infants and newborns requiring intensive care in a neonatal unit.



us.intersurgical.com/info/phthalates



Code	Description	Length	Box Qty.
1160032	Infant, nasal cannula with curved prongs and tube	2.1m	50 
1160031	Neonatal, nasal cannula with curved prongs and tube	2.1m	50 
1160030	Premature, nasal cannula with curved prongs and tube	2.1m	50 

Make an inquiry

Reduce the pressure

Intersurgical has two products to reduce the occurrence of pressure ulcers on the ear

Intersurgical EcoLite™ oxygen masks



Intersurgical EcoLite oxygen masks featuring:

- Under ear elastic position eliminating trauma to top of ears
- Soft face seal
- Light weight

Nasal cannula with ear guards



Nasal cannula with ear guards featuring:

- Soft silicone foam cushions
- Easily adjustable
- Securely fitted
- Non-allergenic

For a sample and further information visit us.intersurgical.com/info/reducethepressure

Intersurgical EcoLite™ one of the lightest and most comfortable range of oxygen and aerosol masks

Welcome to the Comfort Zone

The unique design and materials used to manufacture the Intersurgical EcoLite mask provides improved patient comfort and a reduced environmental impact.

Comfortable for the Patient

Improved patient comfort has been key to the development of the Intersurgical EcoLite mask. The latest manufacturing technology has enabled us to combine two non-PVC materials in the same product. The polypropylene material which forms the body of the Intersurgical EcoLite mask is clear, lightweight and rigid enough to maintain the masks shape. The second softer thermoplastic elastomer (TPE) material is utilized in the seal, to help eliminate discomfort on the patient's face.

Comfortable for the Environment

The Intersurgical EcoLite mask is an important part of our Eco range, designed as part of our ongoing focus on sustainable development. Various groups have questioned the use of PVC in medical products and its impact on the environment. The utilization of alternative materials has resulted in the elimination of PVC from the Intersurgical EcoLite mask, reducing the environmental impact.



us.intersurgical.com/info IntersurgicalEcoLite

Adult Medium concentration oxygen mask

Incurved nose seal

Conforms to different nose shapes designed to prevent oxygen from entering the patient's eyes

No metal nose clip

MRI compatible

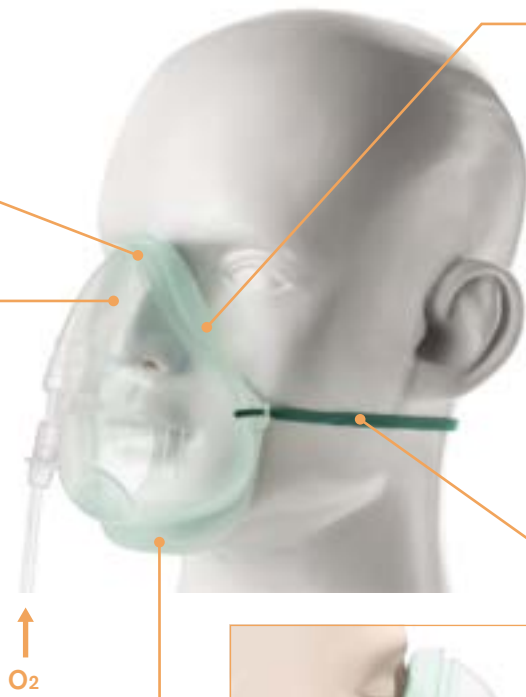

Soft face seals

Increases patient comfort

Lighter

50% lighter than a PVC mask, more comfortable for the patient

Greener

The elimination of PVC from the masks has dramatically lowered their environmental impact

Elastic can be positioned under or over the ears

Below ear position eliminates trauma to top of ears

A choice of "under chin" or "on chin" positions

Provides a better fit on a wider range of patient face shapes



Make an inquiry

Code	Description	Tube length	Box Qty.
1136015	Intersurgical EcoLite, adult, medium concentration oxygen mask		55
11366100	Intersurgical EcoLite, adult, medium concentration oxygen mask with Universal Connector tube	1.8m	30
1135015	Intersurgical EcoLite, adult, medium concentration oxygen mask with tube	2.1m	40





Intersurgical EcoLite™ Pediatric medium concentration oxygen mask

The Intersurgical EcoLite pediatric medium concentration oxygen mask is one of the lightest and most comfortable pediatric masks available. Every aspect of the design has been addressed, achieving unparalleled levels of comfort and fit. Not only comfortable for the patient but also comfortable for the environment.

The elimination of PVC from the masks has dramatically lowered their environmental impact.



 illustrated

Code	Description	Tube length	Box Qty.
1190015	Intersurgical EcoLite, pediatric, medium concentration oxygen mask		42 
 1196015	Intersurgical EcoLite, pediatric, medium concentration oxygen mask with tube	2.1m	40 
11906100	Intersurgical EcoLite, pediatric, medium concentration oxygen mask with Universal Connector tube	1.8m	20 

Make an inquiry



High concentration oxygen mask

Adult and pediatric high concentration oxygen masks. The Intersurgical EcoLite adult mask design is both comfortable for the patient and seals on the patients face, which results in higher oxygen concentrations as less ambient air enters the mask.

 Video available at www.intersurgical.com



 illustrated

Code	Description	Tube length	Box Qty.
 1181015	Intersurgical EcoLite, adult, high concentration oxygen mask with tube	2.1m	24 
11816100	Intersurgical EcoLite, adult, high concentration oxygen mask with Universal Connector tube	1.8m	20 
11926000	Pediatric, high concentration oxygen mask with tube	2.1m	50

Make an inquiry

 Lower environmental impact product





Silente™ venturi mask kit

The Silente has been designed to operate at a very low noise level. The large diameter body provides space for clear, widely spaced calibration and incorporates a “pull-twist” action to prevent accidental adjustment.

The concentration delivered is unaffected by the patient's breathing pattern provided that the optimum flow indicated on the valve is set on the oxygen flow meter.



 illustrated

Code	Description	Tube length	Box Qty.
 1137015	Silente, Intersurgical EcoLite, adult, adjustable venturi mask kit with tube	1.8m	30 
11376100	Silente, Eco, adult, adjustable venturi mask kit with Universal Connector tube	1.8m	50 
1138015	Silente, Intersurgical EcoLite, pediatric, adjustable venturi mask kit with tube	1.8m	40 
11386100	Silente, Intersurgical EcoLite, pediatric, adjustable venturi mask kit with Universal Connector tube	1.8m	30 
1139030	Silente, adjustable venturi valve only		50

Make an inquiry

Venturi valves

A comprehensive range of Venturi valves available individually. These products are designed to meet the requirements of BS EN 13544-3: 2001 and are color-coded for easy identification.

The flow rate printed on the valves ensures that the patient receives a total flow of approximately 40 L/min. This is designed to meet the patient's 'normal' peak flow requirements.



Code	Description	Box Qty.
 0060000	Venturi valve 60% oxygen, green	50
 0070000	Venturi valve 50% oxygen, pink	50
 0040000	Venturi valve 40% oxygen, red	50
 0035000	Venturi valve 35% oxygen, yellow	50
 0031000	Venturi valve 31% oxygen, orange	50
 0028000	Venturi valve 28% oxygen, white	50
 0024000	Venturi valve 24% oxygen, blue	50

Make an inquiry

 Lower environmental impact product

Venturi valve Eco mask kits

These kits incorporate the Eco masks providing an unprecedented level of comfort and a reduced environmental impact.



Code	Description	Box Qty.
1060080	Eco, adult, oxygen mask with 60% venturi valve, green	40
1040080	Eco, adult, oxygen mask with 40% venturi valve, red	40
1035080	Eco, adult, oxygen mask with 35% venturi valve, yellow	40
1031080	Eco, adult, oxygen mask with 31% venturi valve, orange	40
1028080	Eco, adult, oxygen mask with 28% venturi valve, white	40
1024080	Eco, adult, oxygen mask with 24% venturi valve, blue	40

Intersurgical EcoLite™ adult venturi mask kit

A complete kit comprised of six valves, an adult Intersurgical EcoLite aerosol mask, oxygen tube and humidification cup. The flow rate printed on the valves ensures that the patient receives a total flow of approximately 40 L/min. This is designed to meet the patient's 'normal' peak flow requirements.



[Make an inquiry](#)

Code	Description	Box Qty.
1107085	Intersurgical EcoLite, adult, venturi mask kit	25

Oxygen tubing

Multi-channel tubing. A non-PVC version is available providing an environmentally friendly choice.

[Make an inquiry](#)



illustrated

Code	Description	Tube Length	Box Qty.
1174010	Non-PVC, oxygen tube	2.1m	100
1174030	Multi-Channel Oxygen tube	2.1m	50

Lower environmental impact product

Oxygen tube connectors

Male and female straight oxygen connectors, with 6mm and 6.5mm oxygen stems.

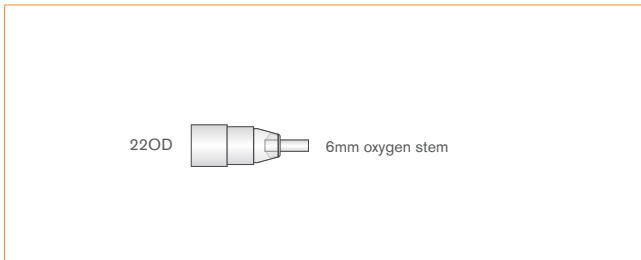

Code	19686000
Box Qty.	50

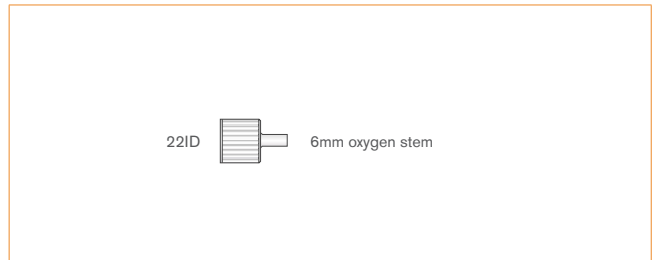

Code	15686000
Box Qty.	50

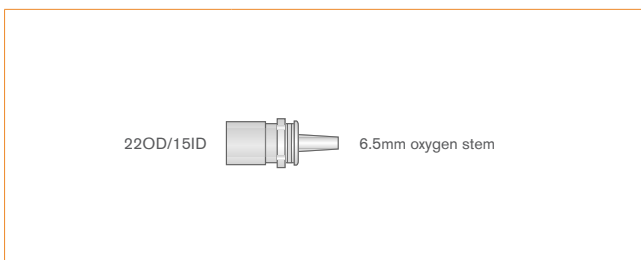

Code	19746000
Box Qty.	50

[Make an inquiry](#)

Intersurgical EcoLite™ Aerosol face masks

A comprehensive range of Intersurgical EcoLite masks, that are made from non-PVC material, for use with all Intersurgical nebulizers. Available in adult and pediatric sizes.



illustrated

	Code	Description	Box Qty.	
	1188015	Intersurgical EcoLite, adult, aerosol mask	50	
	1198015	Intersurgical EcoLite, pediatric, aerosol mask	42	

[Make an inquiry](#)

Lower environmental impact product

Tracheostomy masks and T-pieces



A high quality, lightweight mask with a quick-release elastic for ease of use.

Because we don't use any PVC the environmental impact is significantly less than conventional masks, in fact 82% less.

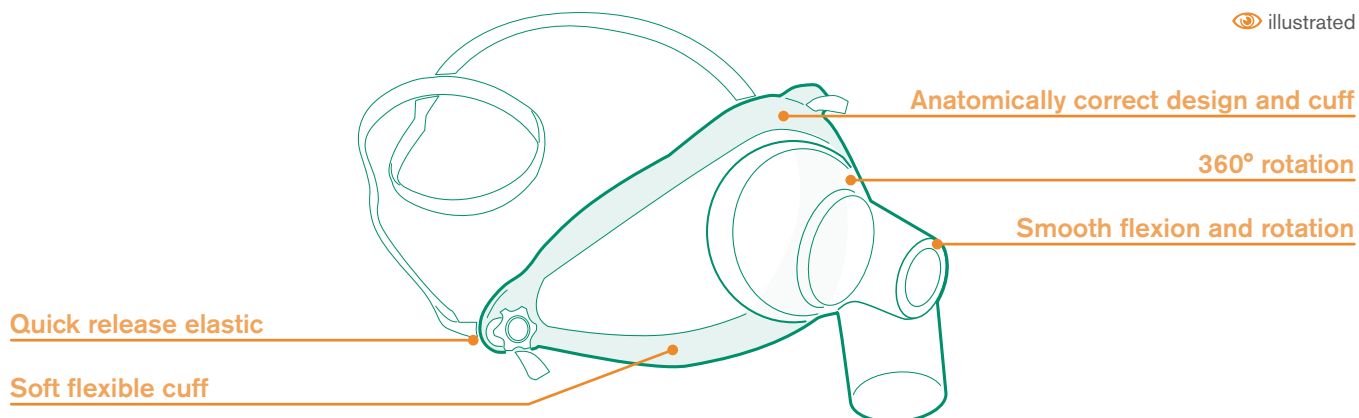

 illustrated



Code	Description	Box Qty.
 1200050	Intersurgical EcoLite, adult, tracheostomy mask	30 
1206030	Pediatric, tracheostomy mask	50
19806000	Tracheostomy T-piece 22OD - 22OD - 22OD/15ID	50
19846000	Tracheostomy T-piece with 7.6mm port 22OD - 22OD - 22OD/15ID	50

Make an inquiry

Aerosol therapy accessories

A range of accessories for aerosol therapy.



Code	Description	Box Qty.
1966001	Straight connector 22OD-MDI port away from patient - 22OD	25
1964001	Straight connector 22OD-MDI port away from patient - 22ID	25
1947001	Straight connector 15OD-MDI port away from patient - 15ID	25
1947003	Straight connector 15OD-MDI port towards patient - 15ID	25
19536000	Anti-pollution T-piece directional valve, 22ID - 22OD - 22OD	50

Make an inquiry

 Lower environmental impact product

Choosing a nebulizer

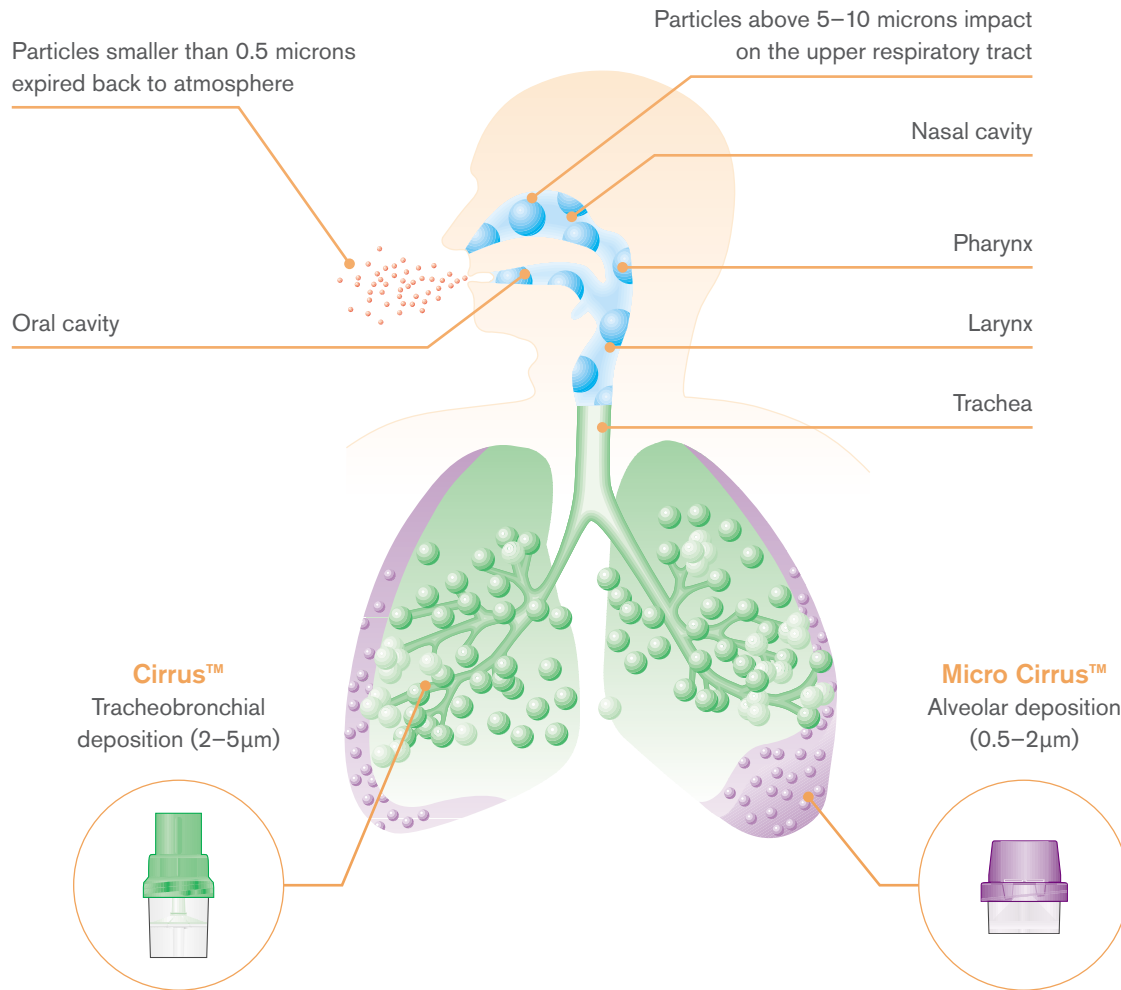

Tracheobronchial deposition



Cirrus nebulizer

The Cirrus nebulizer operates at a driving gas flow of 8 L/min, 80% of the volume output will be particles less than 5 microns in diameter with a MMD of 3.5 microns

Alveolar deposition

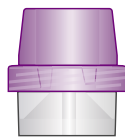

Micro Cirrus nebulizer

The Micro Cirrus has been specifically designed to create a small particle aerosol with a MMD of 1.2 microns

At a driving gas flow of 8 L/min 90% of the particles will be less than 2 microns in diameter

Cirrus™ nebulizer and nebulizer mask kits



Code	Description	Tube length	Box Qty.
14836000	Cirrus adult mask kit with nose clip and oxygen tube	2.1m	50
14846000	Cirrus pediatric mask kit with nose clip and oxygen tube	2.1m	50
15016000	Cirrus nebulizer		50

Make an inquiry

Micro Cirrus™ nebulizer and nebulizer kits

The Micro Cirrus nebulizer has been specifically designed to create a small particle aerosol with a Mass Median Diameter (MMD) of 1.2 microns. At a driving gas flow of 8 L/min 90% of the particles will be less than 2 microns in diameter to give alveolar deposition.



 illustrated

Code	Description	Tube Length	Box Qty.
15036000	Micro Cirrus nebulizer		50
 14176000	Micro Cirrus nebulizer anti-pollution kit with mouthpiece, filter and oxygen tube	2.1m	20
14186000	Micro Cirrus nebulizer mouthpiece/T-kit		50

Make an inquiry

Mouthpieces

Three mouthpieces are available for use with the Cirrus and Micro Cirrus nebulizers.



15106000



1930030



1931030

Code	Description	Box Qty.
15106000	T-mouthpiece 22OD – 22OD – mouthpiece	50
1930030	Straight mouthpiece 22OD – mouthpiece	50
1931030	Straight mouthpiece 22ID – mouthpiece	50

Make an inquiry

T-pieces

The two T-pieces used in our 22mm and 15mm breathing system kits are available individually to allow either Cirrus™ or Micro Cirrus™ to be adapted for use within a breathing system.



18006000



19866000

Code	Description	Box Qty.
18006000	T-piece 15OD – 15ID – 22OD	50
19866000	T-piece 22OD/15ID – 22ID – 22OD	50

[Make an inquiry](#)

More quality, innovation and choice **available online**



Visit our website

We have made significant changes to provide a better online experience for visitors to our website. It is now much easier to navigate around and find what you need. The product images are bigger and better and we've also added educational video clips and literature downloads that provide useful tools for educators and clinicians.

For further information about our product range please contact us at support@intersurgicalinc.com or toll free at 800-828-9633.

www.intersurgical.com

Code	Page	Code	Page	Code	Page	Code	Page
0		15036000	36	1947003	34	2330030	8
0024000	31	15106000	13, 36	19476000	14	2316030	12
0028000	31	1544030	19	1948030	14	2714030	23
0031000	31	1560030	22	19496000	14	3	
0035000	31	15606500	22	19506000	15	3502030	25
0040000	31	15686000	13, 33	19516000	15	3504031S	25
0060000	31	1644030	19	19526000	15	3506000	24
0070000	31	1690030	20	19536000	15, 34	3507031	24
1		17016000	14	19546000	15	3509031	25
1024080	32	1702000	14	19556000	15	3511000	24
1028080	32	17036000	14	19586000	15	3512000	25
1031080	32	17046000	14	19596000	15	3514031	25
1035080	32	17056000	14	19606000	13	3510031	24
1040080	32	17066000	14	19616000	13	3521000	25
1060080	32	1745030	19	19626000	14	35326000	25
1107085	32	1790030	20	19636000	13	5	
1135015	29	18006000	15, 37	1964001	34	5182030	7
1136015	29	18026000	15	19646000	13	5183030	7
11366100	29	1844030	19	19656000	13	5191030	7
1137015	31	1850030	22	1966001	34	59046000	12
11376100	31	18506500	22	19666000	13	59056000	12
1138015	31	1855000	22	19676000	13	7	
11386100	31	18536500	22	19686000	13, 33	7290000	10
1139030	31	1870000	21	19696000	13	7291000	10
1160030	27	1871030	21	19706000	13	7292000	10
1160031	27	1873030	21	19716000	13	7293000	10
1160032	27	1874030	21	19746000	14, 33	7293000	10
1161030	27	18916000	23	19756000	13	7294000	10
1163030	27	1893000	23	19786000	12, 13	7295000	10
1164030	27	1897000	23	19796000	14	7296000	10
1165002	27	1898000	23	19806000	15, 34	9	
1165030	27	1899000	23	19816000	15	91236000	25
1166030	27	19006000	16	19826000	15	B	
1167030	27	19016000	16	19836000	15	B0003000	7
1174010	32	19026000	16	19846000	15, 34	B0003001	7
1174030	32	1903000	16	19856000	15	B0003002	7
1181015	30	1911030	12	19866000	15, 37	B0003003	7
11816100	30	1912030	12	19876000	15	B0006000	7
1188015	33	1915000	12	19886000	15	B0006001	7
1190015	30	1916000	12	19896000	15	B0006002	7
11906100	30	19266000	16	19906000	23	B0006003	7
11926000	30	1927000	16	19916000	23	B0062001	7
1196015	30	19296000	16	19926000	23	B0063000	7
1198015	33	1930030	13, 36	1993030	23		
1200050	34	1931030	13, 36	1995000	23		
1206030	34	19336000	13	1997000	23		
14176000	36	1937000	13	2			
14186000	36	1938000	13	2026030A	9		
14836000	36	19436000	14	2026031A	9		
14846000	36	1944030	19	2026035	9		
15016000	36	19456000	14	2026036	9		
		19466000	14	2310030	8		
		1947001	34	2320030	8		

Intersurgical

6757 Kinne Street
East Syracuse, NY 13057
USA

T: 800-828-9633

F: 315-451-3696

support@intersurgicalinc.com

www.intersurgical.com



Distributor:

www.intersurgical.com/distributors